



## **LevelOne**

FCS-1060/WCS-2060  
P/T/Z IP Network Camera

User Manual

Ver 1.0.1 - 0606

# Before You Use This Product

The use of surveillance devices may be prohibited by law in your country. The Network Camera is not only a high-performance web-ready camera but also can be part of a flexible surveillance system. It is the user's responsibility to ensure that the operation of such devices is legal before installing this unit for its intended use.

It is important to first verify that all contents received are complete according to the list in the "Package Contents" chapter. Take notice of the warnings in "Quick installation guide" before the Network Camera is installed, then carefully read and follow the instructions in the "Installation" chapter to avoid damages due to faulty assembly and installation. This also ensures the product is used properly as intended.

The Network Camera is a network device and its use should be straightforward for those who have basic network knowledge. The "Troubleshooting" chapter in the Appendix provides remedies to the most common errors in set up and configuration. You should consult this chapter first if you run into a system error.

The Network Camera is designed for various applications including video sharing, general security/surveillance, etc. The "How to Use" chapter suggests ways to best utilize the Network Camera and ensure proper operations. For the creative and professional developers, the "URL Commands of The Network Camera" chapter serves to be a helpful reference to customize existing homepages or integrating with the current web server.

For paragraphs preceded by  the reader should use caution to understand completely the warnings. Ignoring the warnings may result in serious hazards or injuries.

# Table of Contents

Before You Use This Product .....	2
Package Contents .....	5
Installation .....	6
Hardware installation .....	6
Software Installation .....	8
Initial Access to the Network Camera .....	11
Check Network Settings .....	11
Add Password to Prevent Unauthorized Access .....	12
How to Use .....	13
Authentication .....	13
Installing plug-in .....	14
Primary user's capability .....	15
Main Screen with Camera View .....	15
Client settings .....	19
Administrator's capability .....	21
Fine-tuning for Best Performance .....	21
Opening accounts for new users .....	23
Build a security application .....	23
Software revision upgrade .....	24
Definitions in Configuration .....	26
System parameters .....	27
Security settings .....	28
Network settings .....	29
Network type .....	29
HTTP .....	29
RTSP Streaming .....	30
WLAN Configuration (WCS-2060 Only) .....	31
DDNS .....	33
Access List .....	34
Audio and Video .....	35
General .....	35
Video Settings .....	35
Video orientation .....	35
Audio settings .....	36
Image Settings .....	37

Camera Control .....	38
Email & FTP .....	40
Email.....	40
FTP .....	40
Motion detection .....	42
Application settings .....	43
Snapshot.....	43
Weekly schedule.....	43
Snapshot file name prefix .....	43
Send out the snapshot while motion detection.....	43
Sequential operation .....	43
Method for sending snapshot.....	44
System log .....	45
Viewing system parameters .....	46
Maintenance .....	47
Appendix .....	48
A. Troubleshooting .....	48
Status LED.....	48
Reset and restore .....	48
B. URL commands of the Network Camera .....	49
Get server parameter values .....	49
Set server parameter values.....	50
Available parameters on the server.....	51
Camera Control .....	61
Recall.....	62
Application page CGI command .....	62
Capture single snapshot.....	64
Account management.....	65
System logs .....	66
Configuration file.....	66
Upgrade firmware .....	67
D. Technical specifications.....	68

# Package Contents

- FCS-1060/WCS-2060
- Dipole Antenna (WCS-2060 Only)
- Power Adapter
- Mounting kit & pads
- CD Manual/Utility
- Quick Installation Guide

# Installation

In this manual, "User" refers to whoever has access to the Network Camera, and "Administrator" refers to the person who can configure the Network Camera and grant user access to the camera.

## Hardware installation

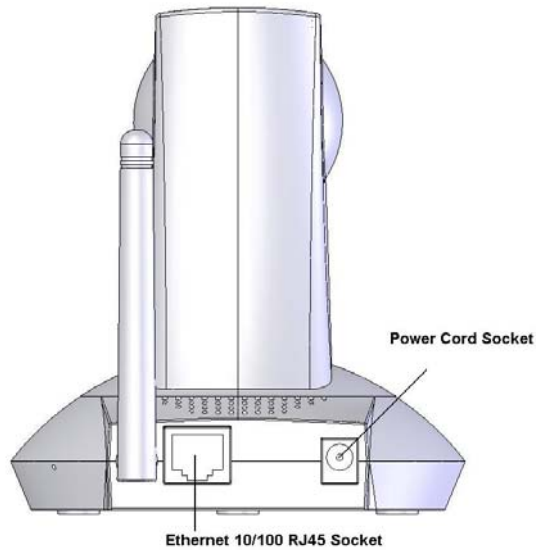

**⚠** Connect the power adapter jack to the Network Camera before plugging in to the power socket. This will reduce the risk of accidental electric shock.

Please verify that your product package contains all the accessories listed in the foregoing Package Contents. Depending on the user's application, an Ethernet cable may be needed. The Ethernet cable should meet the specs of UTP Category 5 and not exceed 100 meters in length.

Upon powering up, the front red LED will become lighted first and then the device will go through booting process. During the booting process, red, blue and green LEDs will be on. After booted, the Network Camera will standby for getting IP address. After getting IP Address, the green LED will blink every second.

The Network Camera will first detect Ethernet. If it does not connect to Ethernet, the Network

Camera will try WLAN. During the searching and connecting process to the wireless access point or station, the red LED of the Network Camera will flash every second. Until the Network Camera connects to the other wireless device, the red LED will become lighted. Operating in either network mode, the green LED will flash every second as heartbeat to indicate alive. If the red LED is blinking, please check the network connections.

***To install in Ethernet***

Make sure the Ethernet is firmly connected to a switch hub. After attaching the Ethernet cable plug in the power adapter. If the LED turns out to be steady blue, go to next paragraph "Software installation". If the Ethernet is not available, Network Camera will switch to wireless LAN mode.

***To install in wireless LAN (WCS-2060 Only)***

If the Ethernet is not available while power on, the Network Camera will search for any access point with the SSID "default". Once any access point is found, the LED will turn blue to wait for installation. If the network environment cannot meet the default settings, install Network Camera in Ethernet to proceed with wireless LAN configuration.

## Software Installation

In this manual, "User" refers to whoever has access to the Network Camera, and "Administrator" refers to the person who can configure the Network Camera and grant user access to the camera.

At the end of the hardware installation, the Administrator must place the product software CD into the CD-ROM drive of the PC running in MS Windows. An auto-run program will pop up (If the program is not on auto-run, go to the root directory of the software CD and click on "autorun.exe").





Click on "Install Software" after the window contains changed, click on "Installation Wizard" to run installation program.



Upon Installation Wizard's start up, a searching box will pop up. This program searches for IP Network Camera on the same LAN:

After searching, Network Cameras will be located by the Installation Wizard. There may be several entries shown in the window. The Administrator may differentiate the Network Cameras with the MAC address.

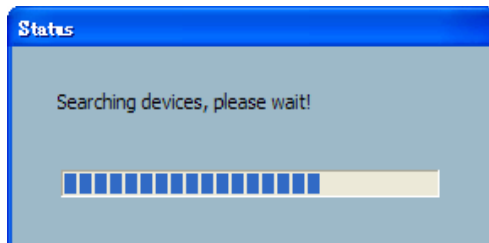

For the MAC address in the “MAC address” field, please check the label on the bottom of the camera.



The IP addresses shown in the "Current IP Address" field reflect those on the local network. They may be from the DHCP server. If there is no DHCP server, the camera will try to find a free IP address (this takes from 15 second to 3 minutes, depending on the LAN status). The method of finding IP address is seeking from 192.168.0.99, to 192.168.0.254. If any of the address inside this range is free, the Network Camera will be assigned to this IP address, and its subnet mask would be 255.255.255.0. If none of the addresses is free, the Network Camera will try the range from 192.168.0.2 to 192.168.0.98. After an IP address is assigned to the camera, the “Activity” status LED blinks.

The UPnP function will always assign an IP address for the Network Camera. The Administrator can click on button “Link to selected device” to connect the I.E. to the camera.

删除:

If the camera is not on the IP installer list, click on the “Search” button to search for the camera on the LAN.

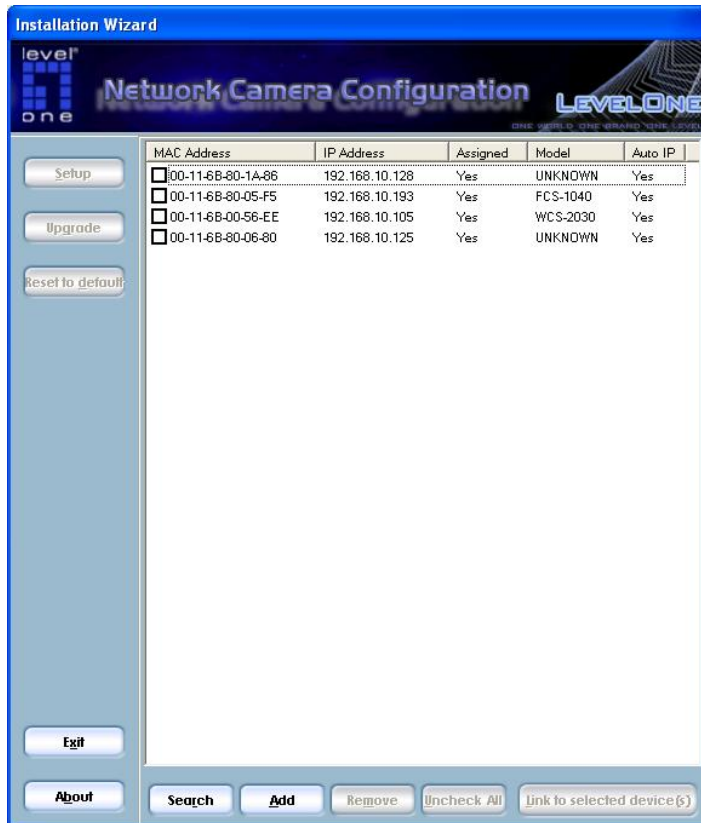

For more detailed usage of the Installation Wizard, please refer to the user manual of the Installation Wizard included in the product CDROM to find the location of the Network Camera. There may be many Network Cameras in the local network. Users can differentiate the Network Cameras with the MAC address. The MAC address is printed on the back of the Network Camera body. Initial Access to the Network Camera

## Check Network Settings

FCS-1060/WCS-2060 IP Network Camera can be connected either before or immediately after software installation onto the Local Area Network. The Administrator should complete the network settings on the configuration page, including the correct subnet mask and IP address of gateway and DNS. Ask your network administrator or Internet service provider for the detail information. By default the Network Camera requires the Administrator to run installation every time it reboots. If the network settings are to remain unchanged, disable the Install option. Refer to "Network settings" on the System Configuration page for details. If any setting is entered incorrectly and cannot proceed to setting up the Network Camera, restore the factory settings following the steps

in the “Troubleshooting” chapter of the Appendix.

## **Add Password to Prevent Unauthorized Access**

The default Administrator’s password is blank and the Network Camera initially will not ask for any password. The Administrator should immediately implement a new password as a matter of prudent security practice. Once the Administrator’s password is saved, the Network Camera will ask for the user’s name and password before each access. The Administrator can set up a maximum of twenty (20) user accounts. Each user can access the Network Camera except to perform system configuration. Some critical functions are exclusive for the Administrator, such as system configuration, user administration, and software upgrades. The user name for the Administrator is permanently assigned as “root”. Once the password is changed, the browser will display an authentication window to ask for the new password. **Once the password is set, there is no provision to recover the Administrator’s password. The only option is to restore to the original factory default settings.**

# How to Use

## Authentication

After opening the Web browser and typing in the URL of the Network Camera, a dialogue window pops up to request a username and password. Upon successful authentication, the following figure is displayed.



\*If the administrator (root user) assigns no password, everybody can access the homepage directly.

## Installing plug-in

For the initial access to the Network Camera in Windows, the web browser may prompt for permission to install a new plug-in for the Network Camera. Permission request depends on the Internet security settings of the user's PC or notebook. If the highest security level is set, the computer may prohibit any installation and execution attempt. This plug-in has been registered for certificate and is used to display the video in the browser. Users may click on  to proceed. If the web browser does not allow the user to continue to install, check the Internet security option and lower the security levels or contact your IT or networking supervisor for help.



# Primary user's capability

## Main Screen with Camera View

The main page layout has three parts:

**Configuration functions:** The camera can be configured using these user interfaces.

**Camera View:** What the camera sees.

**Pan/Tilt control buttons:** These buttons provide a command interface to control the aim of the camera.

Click on the configuration link to the left of the image window to enter the configuration page.

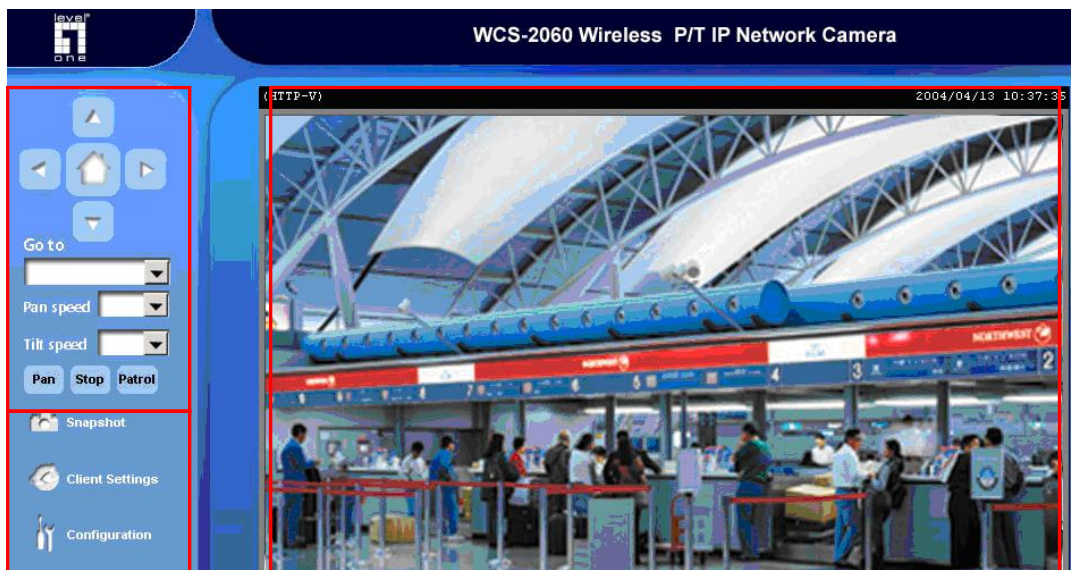

### **The Configuration:**

**“Snapshot”** The button provides users a fast way to capture a single image of the video from the Network Camera.

### **“Client Settings”**

Clicking on this button links you to the client setting pages, please check the following session for more details.

**“Configuration”** Only the Administrator can access camera configurations.

### **The camera view:**

The information bar at the top of the camera view shows the connection type to the Network Camera and the current date/time.

The camera view provides not only the live video, but also a way to aim the Network Camera to different target. Using mouse to click on the target inside the video will command the Network Camera to aim at the target.

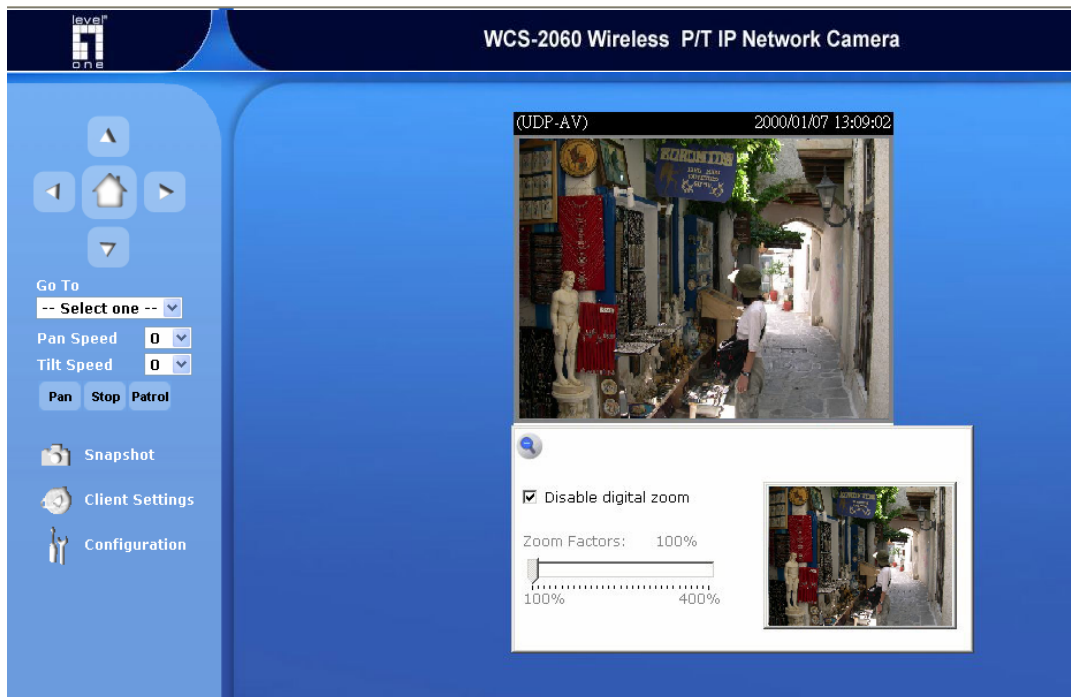

### ***View capabilities***

This feature allows users to open a digital zoom control window to specify the zoom factor for specified area in the camera view. Users can also move the white frame to select the area of the video that she/he wants to view.

**“Disable digital zoom”** The checkbox selection allows users to disable/enable the digital zoom function.

**“Zoom Factors”** The range of zoom factor is from 100% to 400%, users can select any integer factor inside this area.

**“Hide”** Click on this button can close the digital zoom control window.



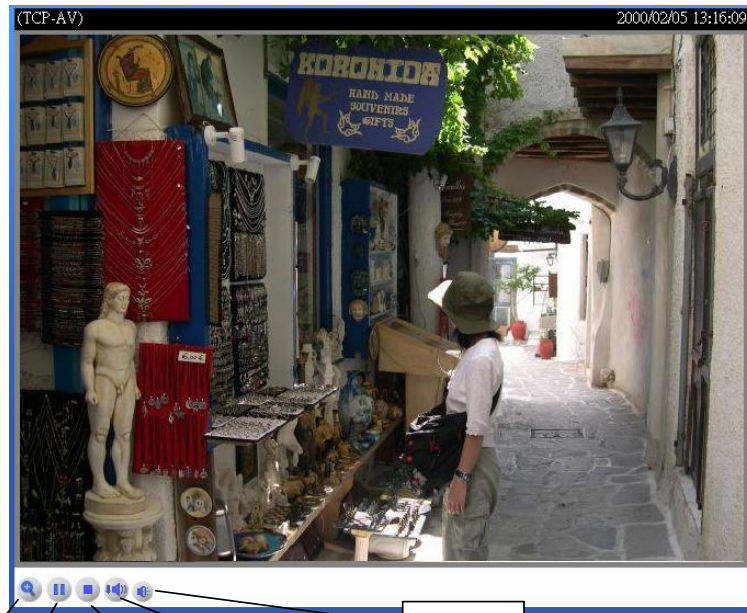

Digital Zoom

Play/Pause

Stop

Mute

Play volume

**“Play”** The option will connect to the Network Camera. The button is the same one as **“Pause”**.

**“Pause”** The option will pause the video, but the connection remains. The button is the same one as **“Play”**.

**“Stop”** The option will disconnect to the Network Camera.

**“Play volume”** Click on this button can adjust the audio volume.

**“Mute”** Disable audio at client side.

***The pan/tilt control buttons:***

The direction buttons are for Left, Right, Up, Down, and Home functions. The Home button centers the camera.

**“Go to”** Once the Administrator has determined the preset positions; the User can aim the camera using this control.

**“Pan speed”**

This button sets the moving range of the “Left” and “Right” commands.

**“Tilt speed”**

This button sets the moving range of the “Up” and “Down” commands.

**“Pan”**

This button commands the camera to pan from the current position to the left-most and then to the right-most position. After panning, the camera returns to the original position.

**“Patrol”**

This button commands the camera to patrol between the preset positions on the Patrol List, which can be modified on the “Camera control page”. After one patrol cycle, the camera returns to the original position.

**“Stop”** This stop the “Auto Pan” command or “Auto Patrol” command.

## Client settings

At the initial access to the “Connection type” page in Windows, the web browser will ask for a new plug-in installation, the plug-in being the Network Camera. This plug-in has been registered for certification and can be used to change the parameters at the client’s site. The user may click on  to install the plug-in. If the web browser does not allow the user to complete the installation, check the Internet security to lower the security level or contact your IT or networking supervisor.

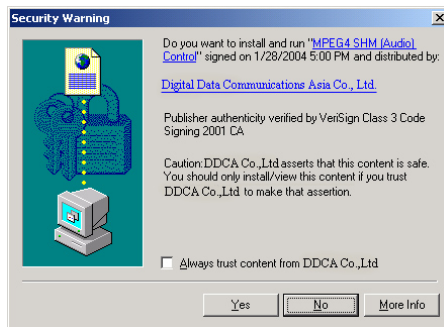

There are two settings for the client side. One is “**Media Options**” for users to determine the type of media to be streaming. The other is “**Protocol Options**” which allows choices on connection protocol between client and server. There are two protocols choices to optimize your usage – UDP and TCP.

The **UDP** protocol allows for more real-time audio and video streams. However, some packets may be lost due to network burst traffic and images may be obscured.

The **TCP** protocol allows for less packet loss and produces a more accurate video display. The downside with this protocol is that the real-time effect is worse than that with the UDP protocol. If no special need is required, UDP protocol is recommended. Generally speaking, the client’s choice will be in the order of UDP → TCP. After the Network Camera is connected successfully, “Protocol Option” will indicate the selected protocol. The selected protocol will be recorded in the user’s PC and will be used for the next connection. If the network environment is changed, or the user wants to let the web browser to detect again, manually select the UDP protocol, save, and return HOME to re-connect.

<url> <http://<Network Camera>/client.html>

<Network Camera> is the domain name or the original IP address of the Network Camera.

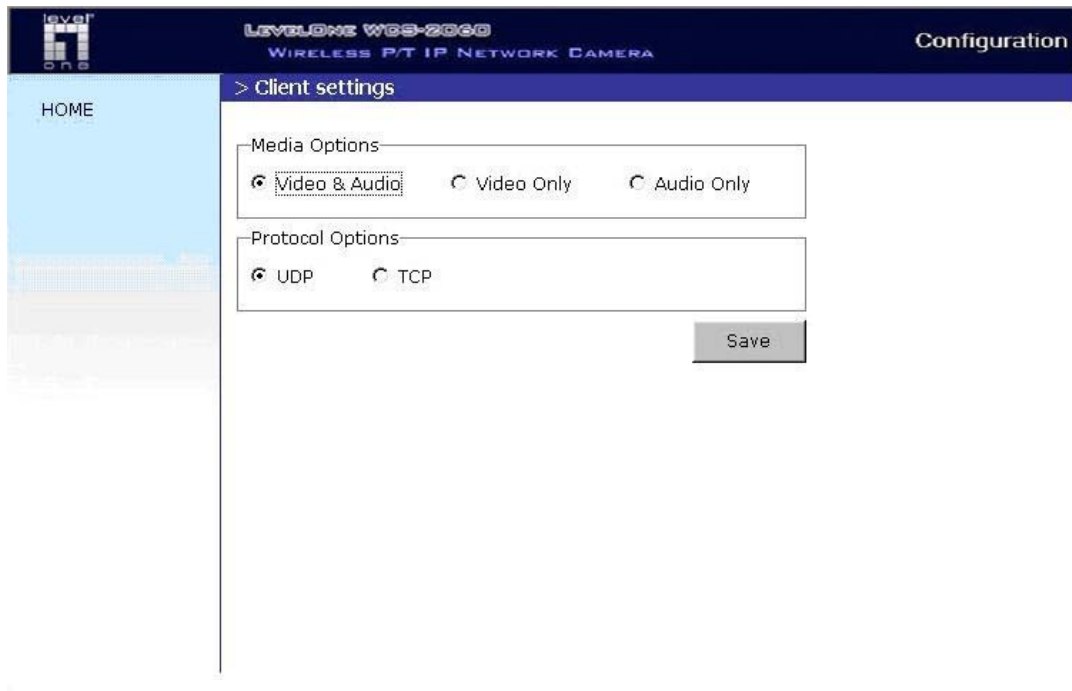

# Administrator's capability

## Fine-tuning for Best Performance

Best performance generally equates to the fastest image refresh rate with the best video quality, and at the lowest network bandwidth as possible. The three factors, "Maximum frame rate", "Constant bit rate", and "Fix quality" on the Audio and Video Configuration page, are correlative to allow for achieving the best performance possible.

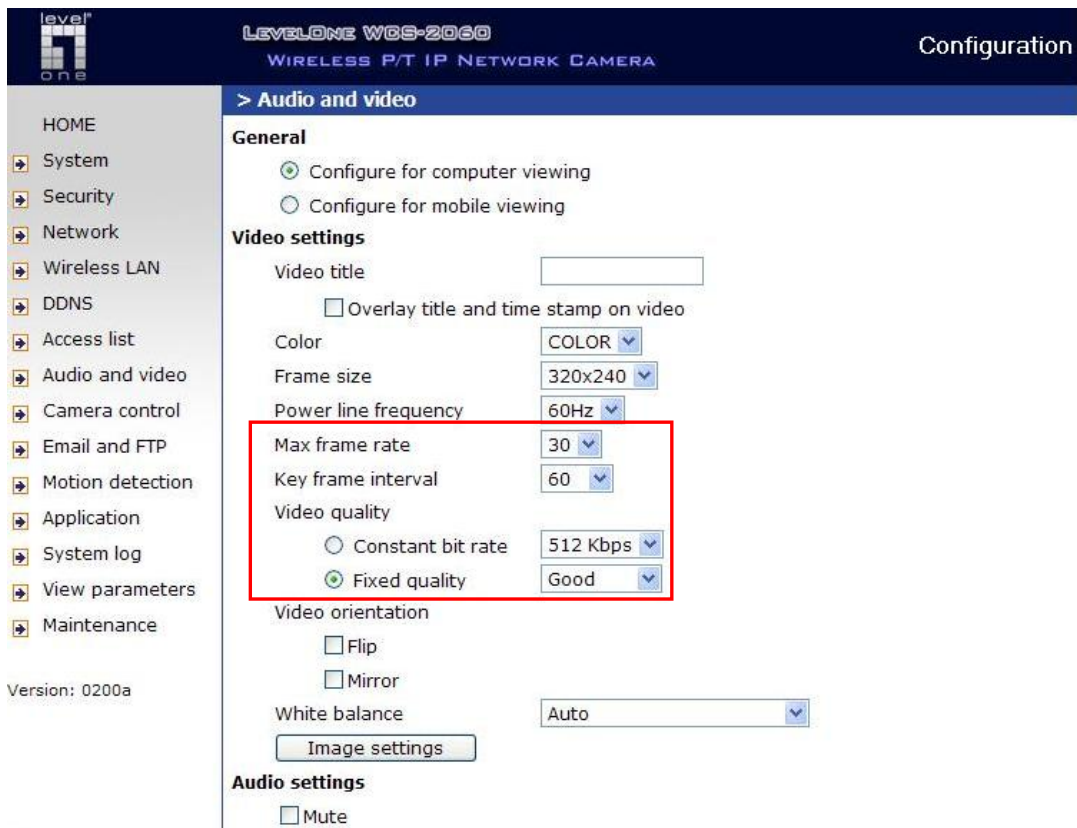

### For Viewing by Mobile Phone

Most 3GPP cell phone supports media streaming with MPEG4 video and GSM-AMR audio. Due to the limitation of the bandwidth for 3GPP, only 176x144 size video is supported for cell phone viewing. Select the "Configure for mobile viewing" option will change the range of other related video settings.

### ***For Best Real-time Video Images***

To achieve good real-time visual effect, the network bandwidth should be large enough to allow a transmission rate of greater than 20 image frames per second. If the broadband network is over 1 Mbps, set the "Fix bit rate" to 1000Kbps or 1200Kbps. The maximum frame rate is 30. If your network bandwidth is more than 512Kbps, you can fix the bit rate according to your bandwidth and set the maximum frame rate to 30 fps. If the images vary dramatically in your environment, you may want to slow the maximum frame rate down to 20 fps in order to lower the rate of data transmission. This allows for better video quality and the human eyes cannot readily detect the differences between those of 20, 25, or 30 frames per second. If your network bandwidth is below 512 Kbps, set the "Fix bit rate" according to your bandwidth and try to get the best performance by fine-tuning with the "Maximum frame rate". In a slow network, greater frame rate results in blur images. Another work-around is to choose "160x120" in the "Size" option for better images. Video quality performance will vary somewhat due to the number of users viewing on the network; even when the parameters have initially been finely tuned. Performance will also suffer due to poor connectivity because of the network's burst constraint.

### ***Only Quality Images Will Do***

To have the best video quality, you should set "Fix quality" at "Detailed" or "Excellent" and adjust the "Maximum frame rate" to match your network's bandwidth. If your network is slow and you receive "broken" pictures, go to the TCP protocol in "Connection type" and choose a more appropriate mode of transmission. The images may suffer a time delay due to a slower connection. The delay will also increase with added number of users.

### ***Somewhere Between Real-time and Clear Images***

If you have a broadband network, set "Fix quality" at "Normal" or better, rather than setting "Fix bit rate". You can also fix the bandwidth according to your actual network speed and adjust the frame rate. Start from 30 fps down for best results but not below 15 fps. If the image qualities are not improved, select a lower bandwidth setting.

## Opening accounts for new users

The screenshot shows the configuration interface for a LevelOne WBS-2060 Wireless P/T IP Network Camera. The interface is titled "Configuration" and has a sidebar menu on the left with options like HOME, System, Security, Network, Wireless LAN, DDNS, Access list, Audio and video, Camera control, Email and FTP, Motion detection, Application, System log, View parameters, and Maintenance. The main content area is titled "> Security" and contains three sections:

- 1** **root password**: A section with a warning "\* Blank root password will disable user authentication". It contains two password input fields labeled "Root password" and "Confirm password", and a "Save" button.
- 2** **Add user**: A section with two input fields labeled "User name" and "User password", and an "Add" button.
- 3** **Manage user**: A section with a dropdown menu labeled "User name" (currently showing "-- no user --") and a "delete" button.

Version: 0200a

### ***Protect Network Camera by passwords***

The Network Camera is shipped without any password by default. That means everyone can access the Network Camera including the configuration as long as the IP address is known. It is necessary to assign a password if the Network Camera is intended to be accessed by others. Type a new word twice in ① to enable protection. This password is used to identify the administrator. Then add an account with user name and password for your friends in ②. Network Camera can provide twenty accounts for your valuable customers or friends. You may delete some users from ③.

### **Build a security application**

The Administrator can use the built-in motion detection to monitor any movement to perform many

useful security applications. To upload the snapshots, users can choose either email or FTP according to user's needs. Both e-mail and FTP use the network settings on the Email and FTP page. Refer to the definition section for detail configuration.

1. Click on "**Configuration**" on homepage,
  2. Click on "**Motion detection**" at the left column,
  3. Check "Enable motion detection",
  4. Click on new to have a new window to monitor video,
  5. Type in a name to identify the new window,
  6. Use the mouse to click, hold, and drag the window corner to resize or the title bar to move,
  7. Fine-tune using the "Sensitivity" and "Percentage" fields to best suit the camera's environment. Higher "Sensitivity" detects the slighter motion. Higher "Percentage" discriminates smaller objects,
  8. Clicking on "Save" enables the activity display. Green means the motion in the window is under the watermark set by Administrator and red means it is over the watermark,
  9. Click on "**Application**" at the left column,
  10. Check the weekdays as you need and give the time interval to monitor the motion detection every day,
  11. Select the Trigger on Motion detection.
  12. Set the **delay before detecting next motion** to avoid continuous false alarms following the original event,
  13. Set the number of pre-event and post-event images to be uploaded,
  14. Check the window name set in step 5,
  15. Check the way to upload snapshot,
- Click on save to validate.

← 格式化: 項目符號及編號

## Software revision upgrade

Customers can obtain the up-to-date software from the web site of LevelOne. An easy-to-use Upgrade Wizard is provided to upgrade the Network Camera with just a few clicks. The upgrade function is opened to the Administrator only. To upgrade the system, follow the procedures below.

1. Download the firmware file named "xxx.pkg" from the appropriate product folder.
2. Run the Upgrade Wizard and proceed following the prompts. Refer to the instructions of the Upgrade Wizard for details.
3. Or upgrade firmware from HTTP web page directly
3. The whole process will finish in a few minutes and it will automatically restart the system.





If power fails during the writing process of Flash memory, the program in the memory of the Network Camera may be destroyed permanently. If the Network Camera cannot restart properly, ask your dealer for technical service.

# Definitions in Configuration

Only the Administrator can access system configuration. Each category in the left column will be explained in the following pages. The bold texts are the specific phrases on the Option pages. The Administrator may type the URL below the figure to directly enter the frame page of configuration. If the Administrator also wants to set certain options through the URL, read the reference appendix for details.

The screenshot shows the configuration interface for a LevelOne WCS-2060 Wireless P/T IP Network Camera. The page is titled "Configuration" and is currently displaying the "System" settings. The left sidebar contains a navigation menu with options: HOME, System (selected), Security, Network, Wireless LAN, DDNS, Access list, Audio and video, Camera control, Email and FTP, Motion detection, Application, System log, View parameters, and Maintenance. The main content area shows the following settings:

- Host name: WCS-2060 Wireless
- Turn off the LED indicator
- Keep current date and time
- Sync with computer time
  - PC date: 2006/04/04 [yyyy/mm/dd]
  - PC time: 19:01:07 [hh:mm:ss]
- Manual
  - Date: 2001/01/16 [yyyy/mm/dd]
  - Time: 15:21:23 [hh:mm:ss]
- Automatic
  - NTP server: skip to invoke default server
  - Time zone: GMT+8:00
  - Update interval: One hour

A "Save" button is located at the bottom of the configuration area. The version number "Version: 0200a" is displayed in the bottom left corner.

<http://<Network Camera>/setup/config.html>

<Network Camera> is the domain name or original IP address of the Network Camera.

<http://<Network Camera>/setup/system.html>

<Network Camera> is the domain name or original IP address of the Network Camera.

## System parameters

**"Host name"** The text displays the title at the top of the main page.

**"Turn off the LED indicator"** Check this option to shut off the LED on the rear. It can prevent the camera's operation being noticed.

**"Keep current date and time"** Click on this to reserve the current date and time of the Network Camera. An internal real-time clock maintains the date and time even when the power of the system is turned off.

**"Sync with computer time"** Synchronizes the date and time of the Network Camera with the local computer. The read-only date and time of the PC is displayed as updated.

**"Manual"** Adjust the date and time according to what is entered by the Administrator. Notice the format in the related fields while doing the entry.

**"Automatic"** Synchronize with the NTP server over the Internet whenever the Network Camera starts up. It will fail if the assigned time-server cannot be reached.

**"NTP server"** Assign the IP address or domain name of the time-server. Leaving the text box blank connects the Network Camera to the default time-servers.

**"Time zone"** Adjust the time with that of the time-servers for local settings.

**"Update interval"** Select hourly, daily, weekly, or monthly update with the time on the NTP server.

Remember to click on  to immediately validate the changes. Otherwise, the correct time will not be synchronized.

## Security settings

**“Root password”** Change the Administrator’s password by typing in the new password identically in both text boxes. The typed entries will be displayed as asterisks for security purposes. After pressing **Save**, the web browser will ask the Administrator for the new password for access.

**“Add user”** Type the new user’s name and password and press **Add** to insert the new entry. The new user will be displayed in the user name list. There is a maximum of twenty user accounts.

**“Manager user”** Pull down the user list to find the user’s name and press **Delete** to complete.

The screenshot shows the configuration interface for a LevelOne WGS-2060 Wireless P/T IP Network Camera. The page is titled "Configuration" and has a navigation menu on the left with options like HOME, System, Security, Network, Wireless LAN, DDNS, Access list, Audio and video, Camera control, Email and FTP, Motion detection, Application, System log, View parameters, and Maintenance. The "Security" section is active, showing three sub-sections: "Root password" with fields for "Root password" and "Confirm password" (both masked with asterisks) and a "Save" button; "Add user" with fields for "User name" and "User password" and an "Add" button; and "Manage user" with a dropdown menu for "User name" (currently showing "-- no user --") and a "delete" button. A note above the password fields states: "\* Blank root password will disable user authentication". The version number "Version: 0200a" is visible at the bottom left.

<http://<Network Camera>/setup/security.html>

<Network Camera> is the domain name or original IP address of the Network Camera.

## Network settings

Any changes made on this page will restart the system in order to validate the changes. Make sure every field is entered correctly before clicking on .

### Network type

#### “LAN” & “PPPoE”

The default type is LAN. Select PPPoE if using ADSL

#### “Get IP address automatically” & “Use fixed IP address”

The default status is “Get IP address automatically”. This can be tedious having to perform software installation whenever the Network Camera starts. Therefore, once the network settings, especially the IP address, have been entered correctly, select “Use fixed IP address” then the Network Camera will skip installation at the next boot. The Network Camera can automatically restart and operate normally after a power outage. Users can run IP installer to check the IP address assigned to the Network Camera if the IP address is forgotten or using the UPnP function provided by the Network Camera (MS Windows XP provides UPnP function at **My Network Place**). “IP address” This is necessary for network identification.

“Subnet mask” This is used to determine if the destination is in the same subnet. The default value is “255.255.255.0”.

“Default router” This is the gateway used to forward frames to destinations in a different subnet.

Invalid router setting will fail the transmission to destinations in different subnet.

“Primary DNS” The primary domain name server that translates hostnames into IP addresses.

“Secondary DNS” Secondary domain name server that backups the Primary DNS.

“Enable UPnP presentation” Enable the UPnP camera short cut

“Enable UPnP port forwarding” Enable uPnP port forwarding

“PPPoE” If using the PPPoE interface , fill the following settings from ISP

“User name” The login name of PPPoE account

“Password” The password of PPPoE account

“Confirm password” Input password again for confirmation

### HTTP

“Http port” This can be other than the default Port 80. Once the port is changed, the users must be notified the change for the connection to be successful. For instance, when the Administrator changes the HTTP port of the Network Camera whose IP address is 192.168.0.100 from 80 to

8080, the users must type in the web browser “http://192.168.0.100:8080” instead of “http://192.168.0.100”.

## RTSP Streaming

“**Access name**” This is the access URL for making connection from client software. Using rtsp://<ip address>/<access name> to make connection

“**RTSP port**” This can be other than the default Port 554

The screenshot shows the configuration interface for a LevelOne WBS-2060 Wireless P/T IP Network Camera. The page is titled "Configuration" and is currently on the "Network" tab. The left sidebar contains a navigation menu with options: HOME, System, Security, Network (selected), Wireless LAN, DDNS, Access list, Audio and video, Camera control, Email and FTP, Motion detection, Application, System log, View parameters, and Maintenance. The main content area is divided into sections: "Network type" with radio buttons for "LAN" (selected) and "PPPoE"; "LAN" sub-section with radio buttons for "Get IP address automatically" (selected) and "Use fixed IP address"; and "Fixed IP address" fields for IP address (192.168.10.127), Subnet mask (255.255.255.0), Default router (192.168.10.1), Primary DNS (192.168.10.1), and Secondary DNS. There are also checkboxes for "Enable UPnP presentation" (checked) and "Enable UPnP port forwarding" (unchecked). The "HTTP" section has a field for "HTTP port" set to 80. The "RTSP streaming" section has fields for "Access name" set to live.sdp and "RTSP port" set to 554. The version number "0200a" is displayed at the bottom left.

<url> <http://<Network Camera>/setup/network.html>

<Network Camera> is the domain name or original IP address of the Network Camera.

## WLAN Configuration (WCS-2060 Only)

“**SSID**” (Service Set Identifier), it is a name that identifies a wireless network. Access Points and wireless clients attempting to connect to a specific WLAN (Wireless Local Area Network) must use the same SSID. The default setting is **default**. *Note: The maximum length of SSID is 32 single-byte characters and SSID can't be any of “, <, > and space character.*

“**Wireless mode**” Clicking on the pull-down menu to select from the following options:

▶ “**Infrastructure**” Make the Network Camera connect to the WLAN via an Access Point. (The default setting)

▶ “**Ad-Hoc**” Make the Network Camera connect directly to a host equipped with a wireless adapter in a peer-to-peer environment.

“**Channel**” While in infrastructure mode, the channel is selected automatically to match the channel setting for the selected Access Point. In Ad-Hoc mode, the channel must be manually set to the same channel for each wireless adapter. The default channel setting depends on the installed region.

“**TX rate**” This field is for selecting the maximum transmission rate on the network. The default setting is “auto”, that is the Network Camera will try to connect to the other wireless device with highest transmitting rate.

“**Security**” Select the data encrypt method

▶ “**None**” – No data encryption.

▶ “**WEP**” – allows communication only with other devices with identical WEP settings.

▶ “**WPA-PSK**” – Use WPA pre-shared key.

“**Auth Mode**” Choosing one of the following modes, (Open is the default setting).

▶ “**Open**” – communicates the key across the network.

▶ “**Shared**” – allows communication only with other devices with identical WEP settings.

“**Key length**” The administrator can select the key length among 64 or 128 bits. 64bits is the default setting.

“**Key format**” Hexadecimal or ASCII. “**HEX**” is the default setting.

▶ “**HEX**” digits consist of the numbers 0~9 and the letters A-F.

▶ “**ASCII**” is a code for representing English letters as numbers from 0-127 except “, <, > and space characters that are reserved.

“**Network Key**” Entering a key in either hexadecimal or ASCII format. When selecting different key length, acceptable input length is listed as following:

64 bits key length: 10 Hex digits or 5 characters.

128 bites key length: 26 Hex digits or 13 characters.

Note: When 22(""), 3C(<) or 3E(>) are input in network key, the key format can't be changed to ASCII format.

**“Algorithm”** Choosing one of the following algorithm for WPA-PSK modes

- ▶ **“TKIP”**
- ▶ **“AES”**

**“Pre-shared Key”** Entering a key in ASCII format. The length of the key is 8 ~ 63

**⚠** Some invalid settings may cause the system failing to respond. Change the configuration only if necessary and consult with your network supervisor or experienced users for correct settings. Once the system has lost contact, refer to Appendix A for reset and restore procedures.



<url> <http://<Network Camera>/setup/wireless.html>

<Network Camera> is the domain name or original IP address of the Network Camera.



# DDNS

“**Enable DDNS**” This option turns on the DDNS function.

“**Provider**” The provider list contains four hosts that provide DDNS services. Please connect to the service provider’s website to make sure the service charges.

“**Host Name**” If the User wants to use DDNS service, this field must be filled. Please input the hostname that is registered in the DDNS server.

“**Username/E-mail**” The Username or E-mail field is necessary for logging in the DDNS server or notify the User of the new IP address. Note: when this field is input as “Username” the following field must be input as “Password”.

“**Password/Key**” Please input the password or key to get the DDNS service.

“**Save**” Click on this button to save current settings for the DDNS service and UPnP function.



<url> <http://<Network Camera>/setup/ddns.html>

<Network Camera> is the domain name or original IP address of the Network Camera.

# Access List

The access list is to control the access permission of clients by checking the client IP address. There are two lists for permission control: **Allow List** and **Deny List**. Only those clients whose IP address is in the **Allow List** and not in the **Deny List** can connect to the Network Camera for receiving the audio/video streaming.

Both **Allow List** and **Deny List** consist of a list of IP ranges. If you want to add a new IP address range, type the **Start IP Address** and **End IP Address** in the text boxes and click on the **Add** button. If you want to remove an existing IP address range, just select from the pull-down menu and click on the **Delete** button.

Both the Allow List and Deny List can have 20 entries.

The screenshot shows the configuration interface for the LevelOne WGS-2000 Wireless P/T IP Network Camera. The page title is "Configuration" and the current section is "> Access list". On the left is a navigation menu with options: HOME, System, Security, Network, Wireless LAN, DDNS, Access list (selected), Audio and video, Camera control, Email and FTP, Motion detection, Application, System log, View parameters, and Maintenance. The main content area is divided into three sections: 1. "Allow list" with "Start IP address" and "End IP address" text boxes and an "Add" button. 2. "Delete allow list" with a dropdown menu showing "1.0.0.0 ~ 255.255.255.255" and a "Delete" button. 3. "Deny list" with "Start IP address" and "End IP address" text boxes and an "Add" button. 4. "Delete deny list" with a dropdown menu showing "-- none --" and a "Delete" button. The version number "0200a" is displayed at the bottom left.

<http://<Network Camera>/setup/accesslist.html>

<Network Camera> is the domain name or original IP address of the Network Camera.

# Audio and Video

## General

“**Configure for computer viewing**” To make quick setting for computer viewing

“**Configure for mobile viewing**” To make quick setting for cell phone viewing

## Video Settings

“**Video title**” The text string can be displayed on video

“**Color**” Select either for color or monochrome video display.

“**Frame Size**” There are four options for video sizes. “**160x120**”, “**176x144**”, “**320x240**”, “**640x480**”.

“**Power line frequency (for fluorescent light)**”, the fluorescent light will flash according to the power line frequency that depends on local utility. Change the frequency setting to eliminate uncomfortable flash image when the light source is only fluorescent light.

There are three dependent parameters provided for video performance adjustment.

“**key frame interval**” The Key frame Interval setting determines how frequently a full frame of the source video is preserved in the Timeline. For example, a Key frame interval of 24 will insert a video key frame every 24th frame in the Timeline.

“**Max frame rate**” This limits the maximal refresh frame rate, which can be combined with the “**Video quality**” to optimize bandwidth utilization and video quality. Choose “**Constant bit rate**” if the user wants to fix the bandwidth utilization regardless of the video quality or choose “**Fixed quality**” and select the desired bandwidth. The video quality may be poor due to the sending of maximal frame rate within the limited bandwidth when images are moving rapidly. Consequently, to ensure detailed video quality (quantization rate) regardless of the network, it will utilize more bandwidth to send the maximal frames when images change drastically.

## Video orientation

“**Flip**” Vertically rotate the video.

“**Mirror**” Horizontally rotate the video. Check options both if the Network Camera is installed upside down.

“**White balance**” Adjust the value for best color temperature.

## Audio settings

“mute” Audio mute

“Audio type” Select audio codec “AAC” or “GSM-AMR” and the bit rate

The screenshot shows the configuration interface for a LevelOne WBS-2060 wireless P/T IP network camera. The page is titled "Configuration" and has a navigation menu on the left with options like HOME, System, Security, Network, Wireless LAN, DDNS, Access list, Audio and video, Camera control, Email and FTP, Motion detection, Application, System log, View parameters, and Maintenance. The "Audio and video" section is selected. Under "General", there are radio buttons for "Configure for computer viewing" (selected) and "Configure for mobile viewing". The "Video settings" section includes fields for Video title, a checkbox for "Overlay title and time stamp on video", and dropdown menus for Color (COLOR), Frame size (320x240), Power line frequency (60Hz), Max frame rate (30), and Key frame interval (60). Under "Video quality", there are radio buttons for "Constant bit rate" (512 Kbps) and "Fixed quality" (Good). Under "Video orientation", there are checkboxes for "Flip" and "Mirror", and a dropdown for "White balance" (Auto). A red circle highlights the "Image settings" button. The "Audio settings" section at the bottom has a checkbox for "Mute".

<url> <http://<Network Camera>/setup/audiovideo.html>

<Network Camera> is the domain name or original IP address of the Network Camera.

## Image Settings

Image settings

Click on this button to pop up another window to tune “**Brightness**”,

“**Contrast**”, “**Hue**” and “**Saturation**” for video

compensation. Each field has eleven levels ranged from -5

to +5. In “**Brightness**” and

“**Contrast**” fields the value 0 indicates auto tuning. The

user may press  to

fine-tune the image. When

the image is O.K., press

to set the image

settings.  Click on

this to recall the original

settings without incorporating

the changes.

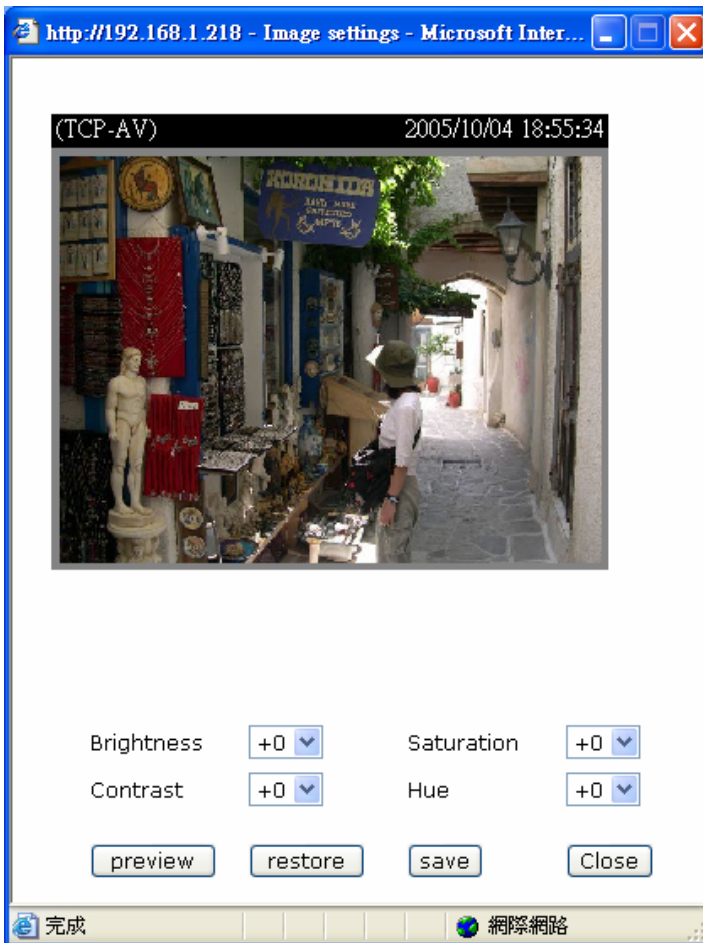

# Camera Control

The screenshot shows the 'Camera control' configuration page for a LevelOne WBS-2060 device. The page is titled 'Configuration' and has a navigation menu on the left. The main content area is divided into two sections:

- Camera control area:** This section contains a large black video feed area. Below it, there are controls for camera movement: 'Up', 'Left', 'Home', 'Right', and 'Down' buttons. There are also three dropdown menus for 'Pan speed' (set to 0), 'Tilt speed' (set to 0), and 'Auto pan/patrol speed' (set to 1).
- Preset function area:** This section is used for defining patrol locations. It includes a 'Dwelling time (sec):' field set to 1. Below this is a 'Patrol selection:' area with two columns: 'Preset locations' and 'Selected locations'. There are 'Select', 'Remove', 'UP', and 'DN' buttons for managing these locations. To the right, there are fields for 'Current position:', 'Preset position:' (set to '--- None ---'), and 'Home definition:' with 'Set as home' and 'Default home' buttons. There are also 'Add' and 'Delete' buttons.

On the Camera Control page, there are two main function control areas:

## **Camera control area**

The pan and tilt functions can be controlled with these buttons. The “Left” button aims the camera to the left; the “Right”, “Up”, and “Down” buttons aim the camera accordingly. The “Home” button aims the camera to the center.

“**Pan speed**” This controls the range of the horizontal movement of the camera. The greater the value, the greater angular movement when performing the “Left” or “Right” functions.

“**Tilt speed**” This controls the range of the vertical movement of the camera. The greater the value, the greater angular movement when performing the “Up” or “Down” functions would be.

“**Auto pan/patrol speed**” This defines the speed of panning and patrol, the greater the value, the faster the speed.

### **Preset function area**

**"Current position"**, If the User wants to save the current view as a preset location, enter a name for each of the current video view at "current position" and click on the "Add" button. The camera allows for 20 preset locations.

**"Preset position"** This keeps a list for preset positions. Clicking on the "Delete" button will remove the current selected position from the preset list.

**"Set as home"** Click on the button will set the current aimed position as home of the Network Camera. Each time the Network Camera reboots or after calibration, it will automatically aim to the defined home position.

**"Default home"** Restore home position to factory default home by clicking on this button.

**"Dwelling time"** The value set here specifies:

1. The stop time of each preset location during auto patrol of the Network Camera.
2. The stay time at the most left and the most right positions when the Network Camera is doing auto panning.

**"Patrol selection"**, After the User has saved a list of preset positions, the "Preset locations" box will also keep a list of the preset positions. And once the "Select>" button is clicked, the "Selected location" box will keep a list of the patrol stops. The "Remove" button removes the preset position from the patrol stops. The "UP", "DOWN" buttons adjust the order of the patrol stops. Several preset positions can be added to the patrol stops. The camera can accept up to 40 patrol stops.

**"Save"** button

The button is valid for "Auto pan/patrol speed", "Enable IR control", "Dwelling time" and "Patrol selections". In other words, after changing these settings, and the "Save" button is not clicked, the new setting of the camera will not take effect.

# Email & FTP

## Email

When the SMTP server support SMTP authentication, users need to give the valid user name and password to send email via the server.

“**Sender email address**”, the email address of the sender.

There are two external mail server can be configured, primary and secondary email server, The network camera will use primary server as default , and use secondary server when primary server is unreachable.

“**Server address**” The domain name or IP address of the external email server.

“**User name**” This granted user name on the external email server.

“**Password**” This granted password on the external email server.

“**Recipient email address**” The email address of the recipients for snapshots or log file. Multiple recipients must be separated by semicolon, ‘;’.

## FTP

“**Built-in FTP server port number**” This can be other than the default port 21. The user can change this value from 1025 to 65535. After the changed, the external FTP client program must change the server port of connection accordingly.

There are two external FTP server can be configured, primary and secondary FTP server, The network camera will use primary server as default , and use secondary server when primary server is unreachable.

“**Server address**” The domain name or the IP address of the external FTP server. The following user settings must be correctly configured for remote access.

“**FTP server port**” This can be other than the default port 21. The user can change this value from 1025 to 65535.

“**User name**” Granted user name on the external FTP server.

“**Password**” Granted password on the external FTP server.

“**Remote folder name**” Granted folder on the external FTP server. The string must conform to that of the external FTP server. Some FTP servers cannot accept preceding slash symbol before



the path without virtual path mapping. Refer to the instructions for the external FTP server for details. The folder privilege must be open for upload.

The screenshot shows the configuration page for a LevelOne WBS-2060 Wireless P/T IP Network Camera. The page is titled "Configuration" and is divided into a left sidebar and a main content area. The sidebar contains a navigation menu with options: HOME, System, Security, Network, Wireless LAN, DDNS, Access list, Audio and video, Camera control, Email and FTP (highlighted), Motion detection, Application, System log, View parameters, and Maintenance. Below the menu, it says "Version: 0200a". The main content area is titled "> Email and FTP" and is divided into three sections: "Email", "FTP", and "Secondary FTP server".

**Email**

Sender email address

**Primary email server**

Server address

User name

Password

Recipient email address

**Secondary email server**

Server address

User name

Password

Recipient email address

**FTP**

Built-in FTP server port number

**Primary FTP server**

Server address

FTP server port

User name

Password

Remote folder name

**Secondary FTP server**

<url> <http://<Network Camera>/setup/mailftp.html>

<Network Camera> is the domain name or original IP address of the Network Camera.

# Motion detection

**“Enable motion detection”** Check this option to turn on motion detection.

**New** Click on this button to add a new window. At most three windows can exist simultaneously. Use the mouse to click, hold, and drag the window frame to resize or the title bar to move. Clicking on the 'x' at the upper right-hand corner of the window to delete the window. Remember to save in order to validate the changes.

**Save** Click on this button to save the related window settings. A graphic bar will rise or fall depending on the image variation. A green bar means the image variation is under monitoring level and a red bar means the image variation is over monitoring level. When the bar goes red, the detected window will also be outlined in red. Going back to the homepage, the monitored window is hidden but the red frame shows when motion is detected.

**"Window Name"** The text will show at the top of the window.

**“Sensitivity”** This sets the endurable difference between two sequential images.

**“Percentage”** This sets the space ratio of moving objects in the monitoring window. Higher sensitivity and small percentage will allow easier motion detection.

The following figure shows the screen when **Save** is clicked. The monitoring window has been outlined in red and the graphic bar goes red since the goldfish is moving.

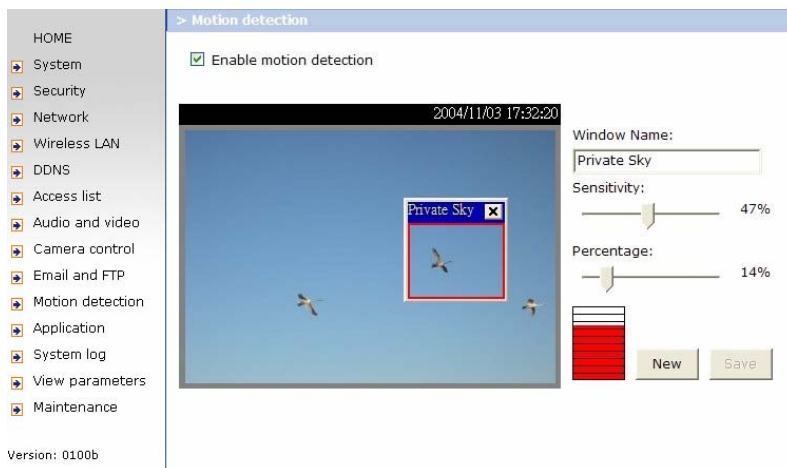

# Application settings

## Snapshot

“**Enable snapshot**” Enable/Disable snapshot application.

## Weekly schedule

“**Sun**” ~ “**Sat**” Select the days of the week to perform the application.  
Select “**Always**” or input the time interval.

## Snapshot file name prefix

The prefix name will be added on the file name of the snapshot images.

## Send out the snapshot while motion detection

There are three windows for motion detection each can be assigned a name. Select the windows which need to be monitored. If motion detection has not been set up, “**undefined**” will be shown instead of the window title. If this happens, clicking on “Motion detection” and a note will show to direct the User to the configuration page for motion detection.

“**Send pre-event image(s)**” The number of pre-snapshots will be captured and send when a condition is triggered.

“**Send post-event image(s)**” The number of post-snapshots will be captured and send when a condition is triggered.

“**Delay second(s) before detecting next motion**” Set the time delay before restarting to check on the triggering condition when the current condition is triggered.

## Sequential operation

“**Snapshot interval : second(s)**” Network Camera will send snapshots at the specified intervals to the external server using the method selected below. Remember: This operation is still subject to the conditions set in the weekly schedule.

## Method for sending snapshot

“**Email**” This selects the uploading method following the intervals set above. The snapshot named “prefix-yyyymmdd-hhmmss.jpg” will be attached in the email.

“**FTP**” The snapshots will be uploaded to the external FTP server with the file name defined in the next option. This can also be used to refresh the captured images stored in the external web server to build creative homepages.

“**FTP put snapshots with date and time suffix**” This option sets up the snapshot capture date and time, which can be used to easily differentiate the snapshot file names in the sequential operation. For instance, “prefix-20030102-030405.jpg” means the JPEG image was captured in the year 2003, January the 2<sup>nd</sup>, at 3 o’clock, 4 minute, and 5 second. If this suffix is omitted, the file named “video.jpg” on the external FTP server will be refreshed at the specified interval.

The screenshot shows a web interface for configuring application settings. On the left is a navigation menu with options like System, Security, Network, and Application. The main content area is titled '> Application' and contains the following sections:

- Snapshot**: An unchecked checkbox for 'Enable snapshot'.
- Weekly schedule**: A row of checkboxes for days of the week (Sun, Mon, Tue, Wed, Thu, Fri, Sat), all of which are unchecked.
- Time**: A radio button selected for 'Always', and an unchecked radio button for 'From 00:00 to 00:00 [hh:mm]'.
- Snapshot file name prefix**: An empty text input field.
- Trigger**: A radio button selected for 'Motion detection'. Below it, it says 'Detect motion in :'. A note reads 'Note: Please configure [Motion detection](#) first.' There are three input fields: 'Send 1 pre-event image(s)', 'Send 1 post-event image(s)', and 'Delay 2 second(s) before detecting the next event'. An unchecked radio button is for 'Sequential', with a sub-option 'Snapshot interval: 5 second(s)'.
- Send snapshot by**: A radio button selected for 'Email', and an unchecked radio button for 'FTP'. Below 'FTP' is an unchecked checkbox for 'FTP put snapshots with date and time suffix' and a 'Save' button.

Version: 0100b

# System log

The Network camera support log the system messages on remote server. The protocol is compliant to RFC 3164. If you have external Linux server with syslogd service, use “-r” option to turn on the facility for receiving log from remote machine. Or you can use some software on Windows which is compliant to RFC 3164.

Check “**Enable remote log**” and input the “**IP address**” and “**port**” number of the log server to enable the remote log facility.

In the “**Current log**”, it displays the current system log file. The content of the log provides useful information about configuration and connection after system boot- up.

The screenshot shows the configuration interface for a LevelOne WBS-2060 Wireless P/T IP Network Camera. The page is titled "Configuration" and has a navigation menu on the left with options like HOME, System, Security, Network, Wireless LAN, DDNS, Access list, Audio and video, Camera control, Email and FTP, Motion detection, Application, System log (highlighted), View parameters, and Maintenance. The main content area is titled "> System log" and is divided into two sections: "Remote log" and "Current log".

**Remote log**

- Enable remote log
- Log server settings
  - IP address:
  - port:
  -

**Current log**

```
Jan 12 08:04:45 SYS: Serial number = 00116b80371b
Jan 12 08:04:46 SYS: System starts at Fri Jan 12 08:04:45 CST 2001
Jan 12 08:04:46 NET: === NET INFO ===
Jan 12 08:04:46 NET: Host IP = 192.168.10.127
Jan 12 08:04:47 NET: Subnet Mask = 255.255.255.0
Jan 12 08:04:47 NET: Gateway = 192.168.10.1
Jan 12 08:04:47 NET: Primary DNS = 192.168.10.1
Jan 12 08:04:48 NET: Secondary DNS =
```

Version: 0200a

## Viewing system parameters

Click on this link on the configuration page to view the entire system's parameter set. The content is the same as those in CONFIG.INI.



The screenshot displays the configuration interface for a LevelOne WCS-2060 Wireless P/T IP Network Camera. The interface is titled "Configuration" and features a sidebar on the left with various configuration categories. The "View parameters" option is selected and highlighted. The main content area, titled "> Parameter list", displays the initial configuration file content, which is a list of system parameters and their values.

```
;PT7137 Initial Configuration File

[system]
<modelname>
WCS-2060
<hostname>
WCS-2060 Wireless
<ledoff>
0
<timezone>
8
<date>
2001/01/16
<time>
14:58:13
<ntp>
skip to invoke default server
<updateinterval>
0
<serialnumber>
00116b80371b
<firmwareversion>
PT7137-LWLO-0200a
<supportscriptversion>
```

Version: 0200a

# Maintenance

Four actions can be selected

“**reboot**” click the reboot button to restart system

“**factory default**” Click on Factory default button on the configuration page to restore the factory default settings. Any changes made so far will be lost and the system will be reset to the initial factory settings. The system will restart and require the installer program to set up the network again.

“**Calibrate**”

Recalibrate the home position to the default center to recover the tolerance caused by some external forces. This function is the same as the “**Center**” button on the Remote Controller. Please note that there is no confirming message box after clicking on the “**Calibrate**” button, the Network Camera will calibrate immediately.

“**upgrade firmware**” Select the firmware file and click upgrade button

The screenshot shows the configuration interface for a LevelOne WBS-2060 Wireless P/T IP Network Camera. The page is titled "Configuration" and is currently displaying the "Maintenance" section. On the left, there is a navigation menu with options: HOME, System, Security, Network, Wireless LAN, DDNS, Access list, Audio and video, Camera control, Email and FTP, Motion detection, Application, System log, View parameters, and Maintenance (which is highlighted). The main content area is titled "> Maintenance" and contains four sections: "Reboot system" with a "Reboot" button; "Factory default" with a "Factory default" button; "Calibrate" with a "Calibrate" button; and "Upgrade firmware" with a text input field for the firmware file, a "Browse..." button, and an "Upgrade" button. The version number "0200a" is displayed at the bottom left of the page.

# Appendix

## A. Troubleshooting

### Status LED

The following table lists the LED patterns in general.

Condition	LED color
Loading system after power on	Steady red
During booting procedure	Steady green, blue and red
Detecting and setting network	Steady green and blue. Blink red till IP address is confirmed
After network is setup (system up)	Blink green every second and steady red
During the upgrade firmware process	Blink green every second and fast blink red
Enable audio	Steady blue. Disable audio will turn off blue LED.

### Reset and restore

There is a button in the back side of the Network Camera. It is used to reset the system or restore the factory default settings.

RESET: Click on the button.

RESTORE:

1. Press on the button continuously.
2. Wait for all LED blink fast.
3. Free the button.



Restoring the factory defaults will erase any previous settings.



## B. URL commands of the Network Camera

For some customers who already have their own web site or web control application, the Network Camera can be easily integrated through convenient URLs. This section lists the commands in URL format corresponding to the basic functions of the Network Camera.

### Get server parameter values

**Note:** This request require administrator access

**Method:** GET/POST

Syntax:

```
http://<servername>/cgi-bin/admin/getparam.cgi?[<parameter>]
[&<parameter>...]
```

where the *<parameter>* should be *<group>[\_<name>]* or *<group>[.<name>]* If you do not specify the any parameters, all the parameters on the server will be returned. If you specify only *<group>*, the parameters of related group will be returned.

When query parameter values, the current parameter value are returned.

Successful control requests returns parameter pairs as follows.

Return:

```
HTTP/1.0 200 OK\r\n
Content-Type: text/html\r\n
Context-Length: <length>\r\n
\r\n
<parameter pair>
```

where *<parameter pair>* is

```
<parameter>=<value>\r\n
```

```
[<parameter pair>]
```

*<length>* is the actual length of content.

**Example:** request IP address and it's response

```
Request:
http://192.168.0.123/cgi-bin/admin/getparam.cgi?network_ipaddress

Response:
HTTP/1.0 200 OK\r\n
Content-Type: text/html\r\n
Context-Length: 33\r\n
\r\n
network.ipaddress=192.168.0.123\r\n
```

## Set server parameter values

**Note:** This request require administrator access

**Method:** GET/POST

Syntax:

```
http://<servername>/cgi-bin/admin/setparam.cgi? [nosync=<value>&]<parameter>=<value>
[&<parameter>=<value>...][&return=<return page>]
```

parameter	value	description
<b>&lt;group&gt;_&lt;name&gt;</b>	value to assigned	Assign <value> to the parameter <group>_<name>..
<b>return</b>	<return page>	Redirect to the page <return page> after the parameter is assigned. The <return page> can be a full URL path or relative path according the the current path. If you omit this parameter, it will redirect to an empty page.  (note: The return page can be a general HTML file(.htm, .html) or a server script executable (.vspcx) file. It can not be a CGI command. It can not have any extra parameters. This parameter must be put at end of parameter list)

Return:

```
HTTP/1.0 200 OK\r\n
Content-Type: text/html\r\n
```

```
Context-Length: <length>\r\n
\r\n
<parameter pair>
```

where <parameter pair> is

```
<parameter>=<value>\r\n
```

```
[<parameter pair>]
```

Only the parameters that you set and readable will be returned.

**Example:** Set the IP address of server to 192.168.0.123

Request:

```
http://myserver/cgi-bin/admin/setparam.cgi?Network\_IPAddress=192.168.0.123
```

Response:

```
HTTP/1.0 200 OK\r\n
```

```
Content-Type: text/html\r\n
```

```
Context-Length: 33\r\n
```

```
\r\n
```

```
network.ipaddress=192.168.0.123\r\n
```

## Available parameters on the server

NOTE: The bold characters in table are the default value of each parameter.

Group: **System**

NAME	VALUE	DESCRIPTION
hostname (r/w)	<text string shorter than 40 characters>	host name of server <b>&lt;&lt;Wireless&gt;Network Camera &gt;</b>
ledoff (r/w)	<b>0</b>	Do not turn off the led indicator
	1	Turn off the led indicator
date (r/w)	<b>&lt;yyyy/mm/dd&gt;</b>	year, month and date separated by slash.
	<keep>	keep date unchanged
	<auto>	Using NTP to sync date/time automatically
time (r/w)	<b>&lt;hh:mm:ss&gt;</b>	hour, minute and second separated by colon.
	<keep>	keep date unchanged

	<auto>	Using NTP to sync date/time automatically
ntp (r/w)	<domain name or IP address>	NTP server <skip to invoke default server>
timezone (r/w)	-12 ~ 12	time zone, 8 means GMT +8:00 <8>
updateinterval (r/w)	0 ~ 2592000	0 to Disable automatic time adjustment, otherwise, it means the seconds between NTP automatic update interval. <0>
serialnumber (r)	<mac address>	12 characters mac address without hyphen connected
firmwareversion (r)	<text string shorter than 39 characters>	The version of firmware, including model, company, and version number
restore (w)	0	Restore the system parameters to default value.
	Positive integer	Restore the system parameters to default value and restart the server after <value> seconds.
reset (w)	0 ~ 65535	Restart the server after <value> seconds.
	-1	Not restart the server.
viewmode (r/w)	0	Using the profile of viewing by computer
	1	Using the profile of viewing by mobile phone

Group: **Security**

NAME	VALUE	DESCRIPTION
username_<1~20> (r/w)	<text string shorter than 16 characters>	change user name. <blank>
userpass_<0~20> (r/w)	<text string shorter than 14 characters>	change user's password. The UserPass_0 is root's password. <blank>
userattr_<1~20> (r)	[conf]	show user's privilege. The privilege can be <blank> - only permit to view live media conf – Permit to change server's configuration <blank>
usercount (r)	1 ~ 21	The current account number on the server including root.<1>

Group: **Network**

NAME	VALUE	DESCRIPTION
type (r/w)	<b>0</b>	LAN
	1	PPPoE
pppoeuser (r/w)	<text string shorter than 80 characters>	PPPoE account user name <b>&lt;blank&gt;</b>
pppoePASS (r/w)	<text string shorter than 15 characters>	PPPoE account password <b>&lt;blank&gt;</b>
resetip (r/w)(restart)	<b>1</b>	enable to get ipaddress, subnet, router, dns1, dns2 from DHCP server at next reboot
	0	Using preset ipaddress, subnet, router, dns1, dns2
ipaddress (r/w) (restart)	<IP address>	IP address of server <b>&lt;192.168.0.99&gt;</b>
subnet (r/w) (restart)	<IP address>	subnet mask <b>&lt;255.255.255.0&gt;</b>
router (r/w) (restart)	<IP address>	default gateway <b>&lt;blank&gt;</b>
dns1 (r/w) (restart)	<IP address>	primary DNS server <b>&lt;blank&gt;</b>
dns2 (r/w) (restart)	<IP address>	secondary DNS server <b>&lt;blank&gt;</b>
smtp1 (r/w)	<domain name or IP address, string shorter than 40 characters>	primary SMTP server <b>&lt;blank&gt;</b>
mailto1 (r/w)	<string shorter than 80 characters>	mail recipient address <b>&lt;blank&gt;</b>
mailuser1 (r/w)	<text string shorter than 63 characters>	User name of primary smtp server <b>&lt;blank&gt;</b>
mailpass1 (r/w)	<text string shorter than 15 characters>	Password of primary smtp server <b>&lt;blank&gt;</b>
smtp2 (r/w)	<domain name or IP address, string shorter than 40 characters>	secondary SMTP server <b>&lt;blank&gt;</b>
mailto2 (r/w)	<text string shorter than 80 characters>	mail recipient address <b>&lt;blank&gt;</b>
mailuser2	<text string shorter than 63 characters>	User name of secondary smtp server

(r/w)	characters>	<b>&lt;blank&gt;</b>
mailpass2 (r/w)	<text string shorter than 15 characters>	Password of secondary smtp server <b>&lt;blank&gt;</b>
returnemail (r/w)	<text string shorter than 80 characters>	return email address <b>&lt;blank&gt;</b>
localftpport (r/w)	<positive number less than 65535>	FTP port <b>&lt;21&gt;</b>
ftp1 (r/w)	<domain name or IP address, string shorter than 40 characters >	primary FTP server <b>&lt;blank&gt;</b>
ftpport1 (r/w)	<positive number less than 65535>	primary FTP port <b>&lt;21&gt;</b>
ftpuser1 (r/w)	<text string shorter than 63 characters>	user name for primary FTP server <b>&lt;blank&gt;</b>
ftppass1 (r/w)	<text string shorter than 15 characters>	password for primary FTP server <b>&lt;blank&gt;</b>
ftpfolder1 (r/w)	<text string shorter than 40 characters>	upload folder in primary FTP server <b>&lt;blank&gt;</b>
ftppasvmode1 (r/w)	1	Enable passive mode of primary FTP server
	0	Disable passive mode of primary FTP server
ftp2 (r/w)	<domain name or IP address, string shorter than 40 characters >	secondary FTP server
ftpport2 (r/w)	<positive number less than 65535>	secondary FTP port <b>&lt;21&gt;</b>
ftpuser2 (r/w)	<text string shorter than 63 characters>	user name for secondary FTP server <b>&lt;blank&gt;</b>
ftppass2 (r/w)	<text string shorter than 15 characters>	password for secondary FTP server <b>&lt;blank&gt;</b>
ftpfolder2 (r/w)	<text string shorter than 40 characters>	upload folder in secondary FTP server <b>&lt;blank&gt;</b>
ftppasvmode2 (r/w)	1	Enable passive mode of primary FTP server
	0	Disable passive mode of primary FTP server
httpport (r/w) (restart)	<positive number less than 65535>	HTTP port <b>&lt;80&gt;</b>
rtspport (r/w) (restart)	<positive number less than 65535>	RTSP port <b>&lt;554&gt;</b>
videoport	<positive number less than	video Channel port for RTP

(r)	65535>	< <b>5558</b> >
audioport (r)	<positive number less than 65535>	audio Channel port for RTP < <b>5556</b> >
accessname (r/w)	<text string shorter than 20 characters>	RTSP access name < <b>live.sdp</b> >

Group: **Wireless (restart)**

ssid (r/w)	<text string shorter than 32 characters>	SSID for wireless lan settings < <b>default</b> >
wlmode (r/w)	<b>0</b> 1	Infrastructure mode Adhoc mode
txrate (r/w)	"NONE", "1M", "2M", "5.5M", "11M", "22M" for 802.11b+ "NONE", "1M", "2M", "5.5M", "11M", "6M", "9M", "12M", "18M", "24M", "36M", "48M", "54M", "Auto" for 802.11g	Transmit rate in Mbps < <b>Auto</b> >
encrypt (r/w)	<b>0</b> 1 2	None data encryption WEP data encryption WPA-PSK data encryption
authmode (r/w)	<b>Open</b> Shared	Open mode Shared mode
keylength (r/w)	( <b>64</b> , 128) for 802.11g	Key length in bits < <b>64</b> >
keyformat (r/w)	<b>HEX</b> ASCII	Key1 ~ Key4 will be represented in HEX format Key1 ~ Key4 will be represented in ASCII format
keyselect (r/w)	1 ~ 4	Default key number < <b>1</b> >
key1 (r/w)	<text string shorter than 58 characters> (depends on keyformat & keylength)	WEP key1 for encryption < <b>0000000000</b> >
key2 (r/w)	<text string shorter than 58 characters> (depends on keyformat & keylength)	WEP key2 for encryption < <b>0000000000</b> >
key3 (r/w)	<text string shorter than 58 characters> (depends on keyformat & keylength)	WEP key3 for encryption < <b>0000000000</b> >

key4 (r/w)	<text string shorter than 58 characters> (depends on keyformat & keylength)	WEP key4 for encryption < <b>0000000000</b> >
algorithm (r/w)	<b>TKIP</b>	TKIP data encryption algorithm for WPA-PSK
	AES	AES data encryption algorithm for WPA-PSK
presaredkey (r/w)	<text string shorter than 58 characters>	WPA-PSK key for encryption < <b>00000000</b> >

Group: **IPFilter**

NAME	VALUE	DESCRIPTION
allowstart_<0~9> (r/w)	1.0.0.0 ~ 255.255.255.255	Allowed starting RTSP connection IP address < <b>1.0.0.0</b> >
allowend_<0~9> (r/w)	1.0.0.0 ~ 255.255.255.255	Allowed ending RTSP connection IP address < <b>255.255.255.255</b> >
denystart_<0~9> (r/w)	1.0.0.0 ~ 255.255.255.255	Denied starting RTSP connection IP address < <b>blank</b> >
denyend_<0~9> (r/w)	1.0.0.0 ~ 255.255.255.255	Denied ending RTSP connection IP address < <b>blank</b> >

Group: **Video**

NAME	VALUE	DESCRIPTION
text (r/w)	<text string shorter than 14 characters>	enclosed caption < <b>blank</b> >
codectype (r/w)	<b>0</b>	MPEG4
	1	MJPEG
keyinterval (r/w)	1, 3, 5, 10, 30, 60, 90, 120	Key frame interval < <b>60</b> >
size (r)	1	half
	2	half x 2
	3	normal
	4	normal x 2
	5	double
	<b>256</b>	This field is obsolete (use resolution)
resolution (r/w)	<b>176x144 (for mobile)</b>	Video resolution 176 x 144
	160x120	Video resolution 160 x 120
	320x240	Video resolution 320 x 240
	<b>640x480 (for computer)</b>	Video resolution 640 x 480



color (r/w)	0	monochrome
	1	color
quality (r/w)	0	fix bit rate
	1	fix quantization
quant (r/w)	1	lowest quality of video
	2	lower quality of video
	3	normal quality of video
	4	higher quality of video
	5	highest quality of video
bitrate (r/w)	20000	set bit rate to 20K bps
	30000	set bit rate to 30K bps
	40000	set bit rate to 40K bps
	50000	set bit rate to 50K bps
	64000	set bit rate to 64K bps
	128000	set bit rate to 128K bps
	256000	set bit rate to 256K bps
	<b>512000</b>	set bit rate to 512K bps
	768000	set bit rate to 768K bps
	1000000	set bit rate to 1000K bps
	1500000	set bit rate to 1500K bps
	2000000	set bit rate to 2000K bps
	3000000	set bit rate to 3000K bps
4000000	set bit rate to 4000K bps	
maxframe (r/w)	1	set maximum frame rate to 1 fps
	2	set maximum frame rate to 2 fps
	3	set maximum frame rate to 3 fps
	5	set maximum frame rate to 5 fps
	10	set maximum frame rate to 10 fps
	15	set maximum frame rate to 15 fps
	20	set maximum frame rate to 20 fps
	25	set maximum frame rate to 25 fps
	<b>30 (for 60Hz only)</b>	set maximum frame rate to 30 fps
	mode (r/w) (in CMOS version only)	50
60		synchronize with 60Hz utility
whitebalance (r/w) (in CMOS)	0	auto white balance
	1	fixed indoor(3200K)

version only)	2	fixed fluorescent (5500K)
	3	fixed outdoor( > 5500K)
flip (r/w)	1	flip image
	0	normal image
mirror (r/w)	1	mirror image
	0	normal image
imprntimestamp (r/w)	1	Overlay time stamp on video
	0	Do not overlay time stamp on video

Group: **Audio**

NAME	VALUE	DESCRIPTION
type (r/w)	<b>AAC4 (for computer)</b>	set codec to AAC
	<b>GAMR (for mobile)</b>	set codec to GSM-AMR
aacbitrate (r/w)	16000	set AAC bitrate to 16K bps
	32000	set AAC bitrate to 32K bps
amrbitrate (r/w)	4750	set AMR bitrate to 4.75K bps
	5150	set AMR bitrate to 5.15K bps
	5900	set AMR bitrate to 5.9K bps
	6700	set AMR bitrate to 6.7K bps
	7400	set AMR bitrate to 7.4K bps
	7950	set AMR bitrate to 7.95K bps
	10200	set AMR bitrate to 10.2K bps
	<b>12200</b>	set AMR bitrate to 12.2K bps

Group: **Image**

NAME	VALUE	DESCRIPTION
brightness (r/w)	<-5 ~ 5>	Adjust brightness of image according to mode settings. <0>
saturation (r/w)	<-5 ~ 5>	Adjust saturation of image according to mode settings. <0>
contrast (r/w)	<-5 ~ 5>	Adjust contrast of image according to mode settings. <0>
hue (r/w)	<-5 ~ 5>	Adjust hue of image according to mode settings. <0>

Group: **CAMCTRL**

NAME	VALUE	DESCRIPTION
panspeed (r/w)	-5 ~ 5	Pan speed
tiltspeed (r/w)	-5 ~ 5	Tilt speed
zoomspeed (r/w)	-5 ~ 5	Zoom speed
autospeed (r/w)	-5 ~ 5	Auto pan speed
dwelling (r/w)	0 ~ 9999	Time to dwelling when patrol
presetname_<0~9> (r/w)	Text string shorter than 40 characters.	The name of preset location
presetpan_<0~9> (r/w)	-1024 ~ 1024	The pan coordinate of preset location.
presettilt_<0~9> (r/w)	-56 ~ 144	The tilt coordinate of preset location.
patrolname_<0~19> (r/w)	Text string shorter than 40 characters.	The name of patrol location

Group: **Motion**

NAME	VALUE	DESCRIPTION
enabled (r/w)	0	disable motion detection
	1	enable motion detection
winenabled_<0~2> (r/w)	0	disable motion window #1
	1	enable motion window #1
winname_<0~2> (r/w)	<text string shorter than 14 characters >	name of motion window #1 <blank>
winleft_<0~2> (r/w)	0 ~ 320	Left coordinate of window position. <0>
wintop_<0~2> (r/w)	0 ~ 240	Top coordinate of window position. <0>
winwidth_<0~2> (r/w)	0 ~ 320	Width of motion detection window. <0>
winheight_<0~2> (r/w)	0 ~ 240	Height of motion detection window. <0>

winobjsize_<0~2> (r/w)	0 ~ 100	Percent of motion detection window <0>
winsensitivity_<0~2> (r/w)	0 ~ 100	Sensitivity of motion detection window <0>
update (w)	1	Update the above motion detection settings to take effect

Group: **DDNS**

NAME	VALUE	DESCRIPTION
enable (r/w)	0, 1	Enable or disable the dynamic dns. <0>
provider (r/w)	1 ~ 6	dyndns.org (dynamic) dyndns.org (custom) tzo.com dhs.org safe100.net dyn-interfree.it <1>
hostname (r/w)	Text string shorter than 127 characters.	Your dynamic hostname. <blank>
usernameemail (r/w)	Text string shorter than 63 characters.	Your user or email to login ddns service provider <blank>
passwordkey (r/w)	Text string shorter than 20 characters.	Your password or key to login ddns service provider <blank>
update (w)	0, 1	Update the above ddns settings to take effect

Group: **UPNP**

NAME	VALUE	DESCRIPTION
enable (r/w)	0, 1	Enable or disable the UPNP presentation service. <1>

Group: **UPNPfor**

NAME	VALUE	DESCRIPTION
------	-------	-------------

enable (r/w)	0, 1	Enable or disable the UPNP port forwarding service. <b>&lt;0&gt;</b>
-----------------	------	---

Group: **App**

NAME	VALUE	DESCRIPTION
scriptname (r)	<text string shorter than 255 characters>	File name of script <b>&lt;script.vssx&gt;</b>
enablescript (r/w)	0	Disable script
	1	Enable script

Group: **Syslog**

NAME	VALUE	DESCRIPTION
enableremotelog (r/w)	0	disable remote log
	1	enable remote log
serverip (r/w)	<b>&lt;IP address&gt;</b>	Log server IP address
serverport (r/w)	<b>&lt;514&gt;</b>	Server port used for log

## Camera Control

**Note:** This request requires camera control access privilege

**Method:** GET/POST

Syntax:

```
http://<servername>/cgi-bin/camctrl.cgi? [move=<value>][&focus=<value>]
[&iris=<value>][&speedpan=<value>][&speedtilt=<value>][&speedzoom=<value>]
[&speedapp=<value>][&auto=<value>][&zoom=<value>][&return=<return page>]
```

parameter	value	description
move	home	Move to camera to home position
	up	Move camera up
	down	Move camera down
	left	Move camera left

	right	Move camera right
speedpan	-5 ~ 5	Set the pan speed
speedtilt	-5 ~ 5	Set the tilt speed
speedapp	-5 ~ 5	Set the auto pan/patrol speed
auto	pan	Auto pan
	patrol	Auto patrol
	stop	Stop camera
return	<return page>	Redirect to the page <return page> after the parameter is assigned. The <return page> can be a full URL path or relative path according to the current path. If you omit this parameter, it will redirect to an empty page.

## Recall

**Note:** This request requires camera control access privilege

Method: GET

Syntax:

```
http://<servername>/cgi-bin/recall.cgi?
recall=<value>[&return=<return page>]
```

parameter	value	description
recall	Text string less than 30 characters	One of the present positions to recall.
return	<return page>	Redirect to the page <return page> after the parameter is assigned. The <return page> can be a full URL path or relative path according to the current path. If you omit this parameter, it will redirect to an empty page.

## Application page CGI command

**Note:** This request requires administrator privilege.

**Method:** GET/POST

Syntax:

```
http://<servername>/cgi-bin/admin/gen-eventd-conf.cgi?[ snapshot_enable=<value>]
[&weekday=<value>][&time_method=<value>][&begin_time=<value>]
[&end_time=<value>]
[&ss_prefix=<value>][&trigger_type=<value>]
[&md_prenum=<value>][&md_postnum=<value>][&md_delay=<value>]
[&sq_interval=<value>]
[&send_method=<value>][&ftp_suffix=<value>]
```

Return:

```
HTTP/1.0 200 OK\r\n
Content-Type: text/plain\r\n
Content-Length: <length>\r\n
\r\n
<depends on method value>
If(method == get || method == set)
{
  tue=<value>\r\n
  wed=<value>\r\n
  ...
}
Else if(method == normal)
{
  Application page contents
}
```

parameter	Value	description
<b>snapshot_enable</b>	0	Enable snapshot application
	1	Disable snapshot application
<b>weekday</b>	0,1,2,3,4,5,6	The array indicate weekly schedule
<b>time_method</b>	<i>always</i>	24 hours full day
	<i>interval</i>	Select begin time and end time
<b>begin_time</b>	<i>hh:mm</i>	Begin time of weekly schedule

<b>end_time</b>	<i>hh:mm</i>	End time of weekly schedule
<b>ss_prefix</b>	< <i>text string shorter than 60 characters</i> >	Snapshot file name prefix for both event and sequential operation
<b>trigger_type</b>	<i>motion</i>	Set trigger by motion detect
	<i>sequential</i>	Snapshot sequentially
<b>md_win</b>	<i>0,1,2</i>	The array indicate which motion windows are used
<b>md_prenum</b>	<i>1~5</i>	The numbers of snapshot before event
<b>md_postnum</b>	<i>1~5</i>	The numbers of snapshot after event
<b>md_delay</b>	<i>1~999</i>	The delay seconds for detecting next motion event
<b>sq_interval</b>	<i>1~999</i>	The interval seconds of sequential snapshot
<b>send_method</b>	<i>mail</i>	Send snapshot by mail
	<i>ftp</i>	Send snapshot by ftp
<b>ftp_suffix</b>	<i>0/1</i>	Enable/Disable file name prefix

## Capture single snapshot

**Note:** This request require normal user privilege

**Method:** GET/POST

Syntax:

<http://<servername>/cgi-bin/video.jpg>

Server will return the most up-to-date snapshot in JPEG format. The size and quality of image will be set according to the video settings on the server.

Return:

```
HTTP/1.0 200 OK\r\n
Content-Type: image/jpeg\r\n
[Content-Length: <image size>\r\n]
<binary JPEG image data>
```



## Account management

**Note:** This request requires administrator privilege

**Method:** GET/POST

Syntax:

```
http://<servername>/cgi-bin/admin/editaccount.cgi?  
method=<value>&username=<name>[&userpass=<value>][&privilege=<value>]  
[&privilege=<value>][...][&return=<return page>]
```

parameter	value	Description
method	add	Add an account to server. When using this method, "username" field is necessary. It will use default value of other fields if not specified.
	delete	Remove an account from server. When using this method, "username" field is necessary, and others are ignored.
	edit	Modify the account password and privilege. When using this method, "username" field is necessary, and other fields are optional. If not specified, it will keep original settings.
username	<name>	The name of user to add, delete or edit
userpass	<value>	The password of new user to add or that of old user to modify. The default value is an empty string.
privilege	<value>	The privilege of user to add or to modify. The privilege can be the addition of the following values. Ex: A user with configure access can be assigned privilege as <b>privilege=conf</b> .
	conf	configuration privilege
return	<return page>	Redirect to the page <return page> after the parameter is assigned. The <return page> can be a full URL path or relative path according the the current path. If you omit this parameter, it will redirect to an empty page.

## System logs

**Note:** This request require administrator privilege

**Method:** GET/POST

Syntax:

```
http://<servername>/cgi-bin/admin/syslog.cgi
```

Server will return the up-to-date system log.

Return:

```
HTTP/1.0 200 OK\r\nContent-Type: text/plain\r\nContent-Length: <syslog length>\r\n\r\n<system log information>\r\n
```

## Configuration file

**Note:** This request requires administrator privilege

**Method:** GET/POST

Syntax:

```
http://<servername>/cgi-bin/admin/configfile.cgi
```

Server will return the up-to-date configuration file.

Return:

```
HTTP/1.0 200 OK\r\nContent-Type: text/plain\r\nContent-Length: <configuration file length>\r\n\r\n<configuration data>\r\n
```

## Upgrade firmware

**Note:** This request requires administrator privilege

Method: POST

Syntax:

```
http://<servername>/cgi-bin/admin/upgrade.cgi
```

**Post data:**

```
fimage=<file name>[&return=<return page>]\r\n\r\n<multipart encoded form data>
```

Server will accept the upload file named <file name> to be upgraded the firmware and return with <return page> if indicated.

## D. Technical specifications

### - System

CPU: VVTK-1000  
RAM: 32MB SDRAM  
ROM: 4MB FLASH ROM

### - Networking

#### Protocol

TCP/IP, HTTP, SMTP, FTP, DDNS, UPnP, Telnet, NTP, DNS, DHCP and RTSP

#### Physical

10 baseT or 100 baseT Fast Ethernet auto negotiation

#### WLAN (WCS-2060 Only)

802.11g wireless LAN

### - Video

Algorithm supported  
MPEG4(simple profile) for streaming video  
JPEG for still image

### - Features

Adjustable image size, quality and bit rate  
Time stamp and text overlay  
3 motion detection windows

### - Resolution

Up to 30/25 frames at 160x120  
Up to 30/25 frames at 320x240  
Up to 30/25 frames at 640x480

### - Camera Specification

1/4 inch color CMOS sensor  
Resolution: 640x480  
1.5Lux/F2.0  
AGC, AWB, AES  
Electronic shutter: 1/60 ~ 1/15000 second

### - Lens

Fixed focal with fine tuning, 4.0mm, F2.0

### - Audio

AAC, GSM-AMR

**- Microphone**

Omni-directional  
Frequency: 50 – 16000Hz  
S/N ratio: more than 60dB

**- LED indicator**

Three color LEDs

**- Dimension**

100mm(D) \* 110mm(W) \* 120mm(H)

**- Weight**

NET. 271g

**- Power**

Input: 100-240VAC, 50/60Hz, 0.5A  
Output: 12VDC, 1.5A  
Consumption: Max 7 W

**- Operating Environment**

Temperature: 0-50°C/32-122°F  
Humidity: 95%RH

**- EMI & Safety**

CE, FCC

**- Viewing system requirement****Operating system**

Microsoft Windows 98SE/ME/2000/XP

**Browser**

Internet Explorer 5.x or above

# GNU GENERAL PUBLIC LICENSE

Version 2, June 1991

Copyright (C) 1989, 1991 Free Software Foundation, Inc.

59 Temple Place, Suite 330, Boston, MA 02111-1307 USA

Everyone is permitted to copy and distribute verbatim copies of this license document, but changing it is not allowed.

## Preamble

The licenses for most software are designed to take away your freedom to share and change it. By contrast, the GNU General Public License is intended to guarantee your freedom to share and change free software--to make sure the software is free for all its users. This General Public License applies to most of the Free Software Foundation's software and to any other program whose authors commit to using it. (Some other Free Software Foundation software is covered by the GNU Library General Public License instead.) You can apply it to your programs, too.

When we speak of free software, we are referring to freedom, not price. Our General Public Licenses are designed to make sure that you have the freedom to distribute copies of free software (and charge for this service if you wish), that you receive source code or can get it if you want it, that you can change the software or use pieces of it in new free programs; and that you know you can do these things.

To protect your rights, we need to make restrictions that forbid anyone to deny you these rights or to ask you to surrender the rights. These restrictions translate to certain responsibilities for you if you distribute copies of the software, or if you modify it.

For example, if you distribute copies of such a program, whether gratis or for a fee, you must give the recipients all the rights that you have. You must make sure that they, too, receive or can get the source code. And you must show them these terms so they know their rights.

We protect your rights with two steps: (1) copyright the software, and (2) offer you this license which gives you legal permission to copy, distribute and/or modify the software.

Also, for each author's protection and ours, we want to make certain that everyone understands that there is no warranty for this free software. If the software is modified by someone else and passed on, we want its recipients to know that what they have is not the original, so that any problems introduced by others will not reflect on the original authors' reputations.

Finally, any free program is threatened constantly by software patents. We wish to avoid the danger that redistributors of a free program will individually obtain patent licenses, in effect making the program proprietary. To prevent this, we have made it clear that any patent must be licensed for everyone's free use or not licensed at all. The precise terms and conditions for copying, distribution and modification follow.

## GNU GENERAL PUBLIC LICENSE

### Terms And Conditions For Copying, Distribution And Modification

0. This License applies to any program or other work which contains a notice placed by the copyright holder saying it may be distributed under the terms of this General Public License. The "Program", below, refers to any such program or work, and a "work based on the Program" means either the Program or any derivative work under copyright law: that is to say, a work containing the Program or a portion of it, either verbatim or with modifications and/or translated into another language. (Hereinafter, translation is included without limitation in the term "modification".) Each licensee is addressed as "you".

Activities other than copying, distribution and modification are not covered by this License; they are outside its scope. The act of running the Program is not restricted, and the output from the Program is covered only if its contents constitute a work based on the Program (independent of having been made by running the Program). Whether that is true depends on what the Program does.

1. You may copy and distribute verbatim copies of the Program's source code as you receive it, in any medium, provided that you conspicuously and appropriately publish on each copy an appropriate copyright notice and disclaimer of warranty; keep intact all the notices that refer to this License and to the absence of any warranty; and give any other recipients of the Program a copy of this License along with the Program.

You may charge a fee for the physical act of transferring a copy, and you may at your option offer warranty protection in exchange for a fee.

2. You may modify your copy or copies of the Program or any portion of it, thus forming a work based on the Program, and copy and distribute such modifications or work under the terms of Section 1 above, provided that you also meet all of these conditions:

a) You must cause the modified files to carry prominent notices stating that you changed the files and the date of any change.

b) You must cause any work that you distribute or publish, that in whole or in part contains or is derived from the Program or any part thereof, to be licensed as a whole at no charge to all third parties under the terms of this License.

c) If the modified program normally reads commands interactively when run, you must cause it, when started running for such interactive use in the most ordinary way, to print or display an announcement including an appropriate copyright notice and a notice that there is no warranty (or else, saying that you provide a warranty) and that users may redistribute the program under these conditions, and telling the user how to view a copy of this License. (Exception: if the Program itself is interactive but does not normally print such an announcement, your work based on the Program is not required to print an announcement.)

These requirements apply to the modified work as a whole. If identifiable sections of that work are not derived from the Program, and can be reasonably considered independent and separate works in themselves, then

this License, and its terms, do not apply to those sections when you distribute them as separate works. But when you distribute the same sections as part of a whole which is a work based on the Program, the distribution of the whole must be on the terms of this License, whose permissions for other licensees extend to the entire whole, and thus to each and every part regardless of who wrote it. Thus, it is not the intent of this section to claim rights or contest your rights to work written entirely by you; rather, the intent is to exercise the right to control the distribution of derivative or collective works based on the Program.

In addition, mere aggregation of another work not based on the Program with the Program (or with a work based on the Program) on a volume of a storage or distribution medium does not bring the other work under the scope of this License.

3. You may copy and distribute the Program (or a work based on it, under Section 2) in object code or executable form under the terms of Sections 1 and 2 above provided that you also do one of the following:

- a) Accompany it with the complete corresponding machine-readable source code, which must be distributed under the terms of Sections 1 and 2 above on a medium customarily used for software interchange; or,
- b) Accompany it with a written offer, valid for at least three years, to give any third party, for a charge no more than your cost of physically performing source distribution, a complete machine-readable copy of the corresponding source code, to be distributed under the terms of Sections 1 and 2 above on a medium customarily used for software interchange; or,
- c) Accompany it with the information you received as to the offer to distribute corresponding source code.

(This alternative is allowed only for noncommercial distribution and only if you received the program in object code or executable form with such an offer, in accord with Subsection b above.)

The source code for a work means the preferred form of the work for making modifications to it. For an executable work, complete source code means all the source code for all modules it contains, plus any associated interface definition files, plus the scripts used to control compilation and installation of the executable. However, as a special exception, the source code distributed need not include anything that is normally distributed (in either source or binary form) with the major components (compiler, kernel, and so on) of the operating system on which the executable runs, unless that component itself accompanies the executable.

If distribution of executable or object code is made by offering access to copy from a designated place, then offering equivalent access to copy the source code from the same place counts as distribution of the source code, even though third parties are not compelled to copy the source along with the object code.

4. You may not copy, modify, sublicense, or distribute the Program except as expressly provided under this License. Any attempt otherwise to copy, modify, sublicense or distribute the Program is void, and will automatically terminate your rights under this License. However, parties who have received copies, or rights, from you under this License will not have their licenses terminated so long as such parties remain in full compliance.

5. You are not required to accept this License, since you have not signed it. However, nothing else grants you permission to modify or distribute the Program or its derivative works. These actions are prohibited by law if



you do not accept this License. Therefore, by modifying or distributing the Program (or any work based on the Program), you indicate your acceptance of this License to do so, and all its terms and conditions for copying, distributing or modifying the Program or works based on it.

6. Each time you redistribute the Program (or any work based on the Program), the recipient automatically receives a license from the original licensor to copy, distribute or modify the Program subject to these terms and conditions. You may not impose any further restrictions on the recipients' exercise of the rights granted herein. You are not responsible for enforcing compliance by third parties to this License.

7. If, as a consequence of a court judgment or allegation of patent infringement or for any other reason (not limited to patent issues), conditions are imposed on you (whether by court order, agreement or otherwise) that contradict the conditions of this License, they do not excuse you from the conditions of this License. If you cannot distribute so as to satisfy simultaneously your obligations under this License and any other pertinent obligations, then as a consequence you may not distribute the Program at all. For example, if a patent license would not permit royalty-free redistribution of the Program by all those who receive copies directly or indirectly through you, then the only way you could satisfy both it and this License would be to refrain entirely from distribution of the Program.

If any portion of this section is held invalid or unenforceable under any particular circumstance, the balance of the section is intended to apply and the section as a whole is intended to apply in other circumstances.

It is not the purpose of this section to induce you to infringe any patents or other property right claims or to contest validity of any such claims; this section has the sole purpose of protecting the integrity of the free software distribution system, which is implemented by public license practices. Many people have made generous contributions to the wide range of software distributed through that system in reliance on consistent application of that system; it is up to the author/donor to decide if he or she is willing to distribute software through any other system and a licensee cannot impose that choice.

This section is intended to make thoroughly clear what is believed to be a consequence of the rest of this License.

8. If the distribution and/or use of the Program is restricted in certain countries either by patents or by copyrighted interfaces, the original copyright holder who places the Program under this License may add an explicit geographical distribution limitation excluding those countries, so that distribution is permitted only in or among countries not thus excluded. In such case, this License incorporates the limitation as if written in the body of this License.

9. The Free Software Foundation may publish revised and/or new versions of the General Public License from time to time. Such new versions will be similar in spirit to the present version, but may differ in detail to address new problems or concerns.

Each version is given a distinguishing version number. If the Program specifies a version number of this License which applies to it and "any later version", you have the option of following the terms and conditions either of that version or of any later version published by the Free Software Foundation. If the Program does

not specify a version number of this License, you may choose any version ever published by the Free Software Foundation.

10. If you wish to incorporate parts of the Program into other free programs whose distribution conditions are different, write to the author to ask for permission. For software which is copyrighted by the Free Software Foundation, write to the Free Software Foundation; we sometimes make exceptions for this. Our decision will be guided by the two goals of preserving the free status of all derivatives of our free software and of promoting the sharing and reuse of software generally.

**NO WARRANTY**

11. BECAUSE THE PROGRAM IS LICENSED FREE OF CHARGE, THERE IS NO WARRANTY FOR THE PROGRAM, TO THE EXTENT PERMITTED BY APPLICABLE LAW. EXCEPT WHEN OTHERWISE STATED IN WRITING THE COPYRIGHT HOLDERS AND/OR OTHER PARTIES PROVIDE THE PROGRAM "AS IS" WITHOUT WARRANTY OF ANY KIND, EITHER EXPRESSED OR IMPLIED, INCLUDING, BUT NOT LIMITED TO, THE IMPLIED WARRANTIES OF MERCHANTABILITY AND FITNESS FOR A PARTICULAR PURPOSE. THE ENTIRE RISK AS TO THE QUALITY AND PERFORMANCE OF THE PROGRAM IS WITH YOU. SHOULD THE PROGRAM PROVE DEFECTIVE, YOU ASSUME THE COST OF ALL NECESSARY SERVICING,

**REPAIR OR CORRECTION.**

12. IN NO EVENT UNLESS REQUIRED BY APPLICABLE LAW OR AGREED TO IN WRITING WILL ANY COPYRIGHT HOLDER, OR ANY OTHER PARTY WHO MAY MODIFY AND/OR REDISTRIBUTE THE PROGRAM AS PERMITTED ABOVE, BE LIABLE TO YOU FOR DAMAGES, INCLUDING ANY GENERAL, SPECIAL, INCIDENTAL OR CONSEQUENTIAL DAMAGES ARISING OUT OF THE USE OR INABILITY TO USE THE PROGRAM (INCLUDING BUT NOT LIMITED TO LOSS OF DATA OR DATA BEING RENDERED INACCURATE OR LOSSES SUSTAINED BY YOU OR THIRD PARTIES OR A FAILURE OF THE PROGRAM TO OPERATE WITH ANY OTHER PROGRAMS), EVEN IF SUCH HOLDER OR OTHER PARTY HAS BEEN ADVISED OF THE POSSIBILITY OF SUCH DAMAGES.

All the source code of LevelOne GPL products are uploaded to <http://www.level1.com>  
All the users can download freely.

